



More Precision

thermoMETER
Non-contact IR temperature sensors





thermoMETER CTlaserFAST

Innovative precision high speed infrared temperature sensor marking the actual spot size on your measurement target at any distance with short response time for extreme fast response.

- High speed temperature sensor with precise laser aiming
- Measuring range from -50°C to 975°C
- 9ms response time for fast moving objects or events
- Extreme small measurement spot down to 1.4mm
- Real mapping of the actual spot size, with automatic laser protection
- Precision optics (50:1) with different models for a specific focus point
- Up to 85°C ambient temperature without cooling
- Fully programmable instrument for enhanced signal processing and I/O control
- Separate controller with easy accessible programming keys and multi colour LCD backlit display

Optical specifications thermoMETER CTlaserFAST

□ = smallest spot size (mm)

Standard optics																
SF50 optics 50:1	20	20.5	21	21.5	22	22.5	23	23.5	24	29.5	35	48	57	68		
distance in mm	0	150	300	450	600	750	900	1050	1200	1350	1500	1800	2100	2400		
Close Focus optics																
CF1 optics 50:1	20	10	8.5	1.4	11	26	41	57	72	60	103	118	133	164	194	225
CF2 optics 50:1	20	15.5	15	12	9	3	11	19	26	33	42	49	57	72	88	103
CF3 optics 50:1	20	16.5	16	14	12	8	4	10	16	21	28	33	40	52	64	76
CF4 optics 50:1	20	19.5	19	18.4	18	16.5	15	14	13	11.5	10	9	12	19	25	32
distance in mm	0	40	50	70	100	150	200	250	300	350	400	450	500	600	700	800

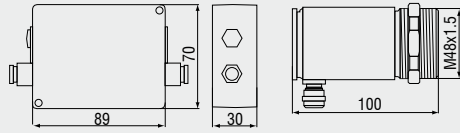

Product identification

CTLF - SF50 - C3

Cable length [3m Standard / 8m / 15m]
Focus [SF50 / CF1 / CF2 / CF3 / CF4]
thermoMETER CTLaserFAST

Model		CTLF-SF50-C3
Optical resolution		50:1
Temperature range ¹		-50°C to 975°C
Spectral range		8 to 14μm
System accuracy ^{2,3}		±1.5% or ±1.5°C
Repeatability ²		±1% or ±1°C
Temperature resolution		0.5°C
Response time (90% signal)		9ms
Emissivity/gain ¹		0.100 to 1.100
Transmissivity/gain ¹		0.100 to 1.000
Signal processing ¹		peak hold, valley hold, average; extended hold function with threshold and hysteresis
Certificate of calibration		optional
Outputs/analogue	channel 1 channel 2 optional	0/4 to 20mA, 0 to 5/10V, thermocouple J, K sensor temperature (-20 to 180°C as 0 to 5V or 0 to 10V), alarm output relay: 2 x 60VDC/ 42VACeff; 0.4A; optically isolated
Alarm output		open - collector (24V/ 50mA)
Outputs/digital	optional	USB, RS232, RS485, CAN, Profibus DP, Ethernet
Output impedances	current output voltage output	mA max. 500Ω (with 5 to 36VDC) mV min. 100kΩ load impedance; thermocouple 20Ω
Inputs		programmable functional inputs for external emissivity adjustment, ambient temperature compensation, trigger (reset of hold functions)
Cable length		3m (standard), 8m, 15m
Power supply		8 to 36VDC; max. 160mA
Laser		class II (635nm), 1mW, ON/OFF via controller or software
Environmental rating		IP 65 (NEMA-4)
Ambient temperature		sensor: -20°C to 85°C (50°C if Laser ON) controller: 0°C to 85°C
Storage temperature		sensor: -40°C to 85°C controller: -40°C to 85°C
Relative humidity		10 to 95%, non condensing
Vibration	sensor	IEC 68-2-6: 3 G, 11 to 200Hz, any axis
Shock	sensor	IEC 68-2-27: 50 G, 11ms, any axis
Weight		sensor: 600g; controller: 420g

¹ adjustable via controller or software

² ± ambient temperature: 23 ±5°C; whichever is greater

³ temperature of the object >0°C

Accessories page 22 - 23

- ▶ Mounting bracket
- ▶ Air purge collar
- ▶ Rail mount adapter for controller
- ▶ Water cooled housing
- ▶ Interface kit
- ▶ Software CompactConnect
- ▶ Certificate of calibration



LASER RADIATION
DO NOT STARE IN THE BEAM
CLASS 2 LASER
EN60825-1:2002
P≤1mW; λ=630-650nm

Controller

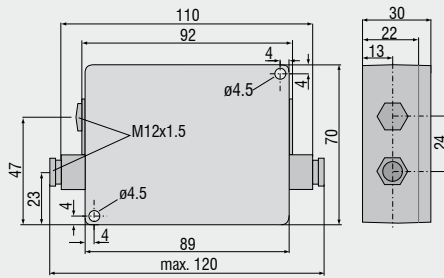

CTLaser / CTLaserFAST / CTLaserGLASS / CTLaserM1/M2 / CTLaserM3 / CTLaserM5 / CTLaserCOMBUSTION

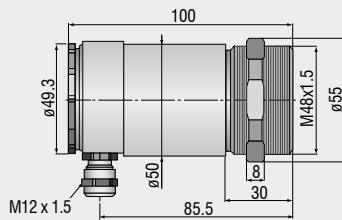

CTratioM1

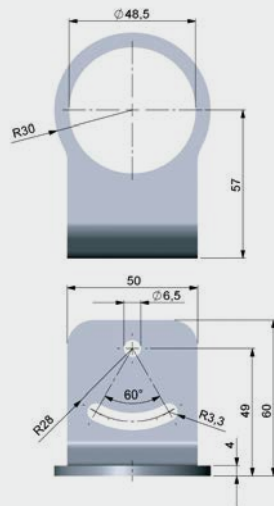
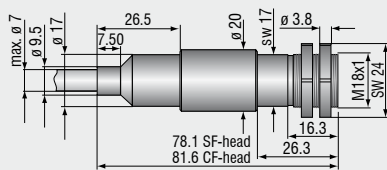

TM-FB-CTL Mounting bracket (fixed); included with CTL sensors

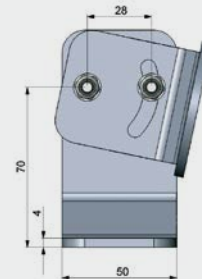

TM-AB-CTL Mounting bracket (adjustable)

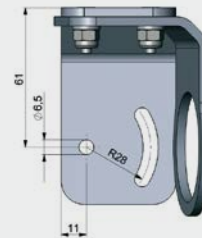

TM-W-CTL Water cooled housing and air purge collar TM-AP-CTL, mounted on adjustable mounting bracket TM-AB-CTL

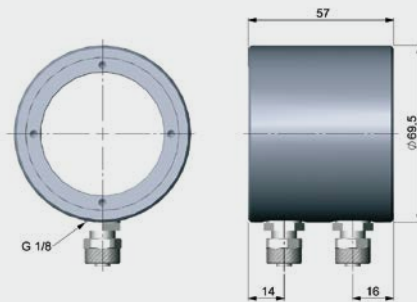

TM-W-CTL Water cooled housing

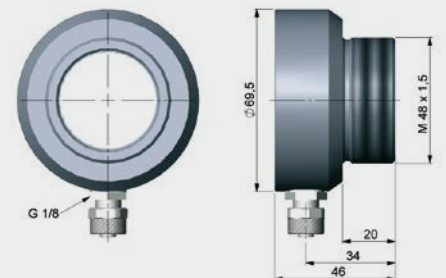

TM-AP-CTL Air purge collar

Mechanical accessories

Art. No.	Model	
2970238	TM-AB-CTL	Mounting bracket, adjustable, stainless steel
2970239	TM-AP-CTL	Air purge collar, stainless steel
2970240	TM-W-CTL	Water cooled housing, stainless steel, for ambient temperatures up to 175°C
2970241	TM-RAIL-CTL	Rail mount adapter for CTlaser controller
2970242	TM-COV-CTL	Closed cover for controller
2970243	TM-MN-CTL	Mounting nut, stainless steel (spare)
2970244	TM-FB-CTL	Mounting bracket, fixed, stainless steel (spare)
2970298	TM-A20UN-CTL	Screw adapter M48x1 on 20UN-2A screw including mounting nut

High temperature accessories

2970366	TM-J-CTL	Cooling jacket (length 228mm, ø89mm) (connection kit TM-CONK-CTL is required)
2970374	TM-CONK-CTL	Connection kit: sensor with axial cable exit, for integration in cooling jacket
2970368	TM-JAB-CTL	Adjustable mounting bracket for cooling jacket
2970369	TM-MF-CTL	Mounting flange M48x1.5 for TM-PF-CTL
2970370	TM-AST300-CTL	Sighting tube M48x1.5, 300 mm length
2970371	TM-PA-CTL	Pipe adapter M48x1.5
2970372	TM-RM-CTL	Furnace wall mount accessory for CTlaser (TM-MF-CTL, TM-AST300-CTL and TM-PA-CTL)
2970412	TM-PF-CTL	Pipe flange M48x1.5 for direct mounting a CTL sensor

Calibration

2970253	TM-CERT-CTL	Certificate of calibration
2970324	TM-HTCERT-CTL	Certificate of calibration for CTlaser M1-/M2-/M3-/M5-/G-sensors

Interfaces

2970245	TM-USBK-CTL	USB interface kit incl. computer cable, software CompactConnect
2970246	TM-RS232K-CTL	RS232 interface kit incl. computer cable, software CompactConnect
2970338	TM-RS485USBK-CTL	RS485-USB-adapter, incl. PC cable, RS485 board, software CTconnect, terminal block, for use with TM-485B-CTL
2970248	TM-RS485B-CTL	RS485 interface board
2970249	TM-CANK-CTL	CAN-Bus interface for optris CT/ protocol: CANopen Presettings: module address 20 (14H), 250kbaud, 0-60°C
2970250	TM-PFBDPK-CTL	Profibus-DPV1 interface for CT selectable with DIN M12 or SUB-D connection
2970251	TM-ETHNK-CTL	Ethernet-Kit: interface board, external Ethernet adapter, software CompactConnect
2970252	TM-RI-CTL	Relay interface: Two optically isolated relays, 60VDC/ 42VAC _{RMS} , 0.4A

Sensor cables and high temperature cables

2970374	TM-CONK-CTL	Connector-Kit for cables with connector
4800254.003	TM-CB3C-CTL	Sensor cable with adapter (3m)
4800254.003H	TM-CB3HC-CTL	High-temperature sensor cable with adapter (3m)
4800254.008	TM-CB8C-CTL	Sensor cable with adapter (8m)
4800254.008H	TM-CB8HC-CTL	High-temperature sensor cable with adapter (8m)
4800254.015	TM-CB15C-CTL	Sensor cable with adapter (15m)
4800254.015H	TM-CB15HC-CTL	High-temperature sensor cable with adapter (15m)



TM-J-CTL Cooling jacket (length 228mm, ø89mm) with adjustable mounting bracket TM-JAB-CTL; up to 315°C ambient temperature



TM-PF-CTL and TM-MF-CTL Mounting flange M48x1.5 for direct mounting a CTL sensor



TM-RM-CTL Furnace wall mount accessory for CTlaser / resp. CTratio: TM-MF-CTL, TM-PF-CTL, TM-AST300-CTL and TM-PA-CTL

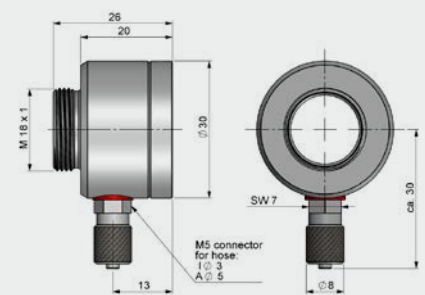

TM-AP-CTR Air purge collar

CTratio

Art. No.	Model	
2970348	TM-FB-CTR	Mounting bracket, adjustable in one axis
2970395	TM-AP-CTR	Air purge collar
2970373	TM-RM-CTR	Furnace wall mount accessory for CTratio
2970351	TM-CERT-CTR	Certificate of calibration

High performance sensors made by Micro-Epsilon



Sensors and systems for displacement and position



Sensors and measurement devices for non-contact temperature measurement



2D/3D profile sensors (laser scanner)

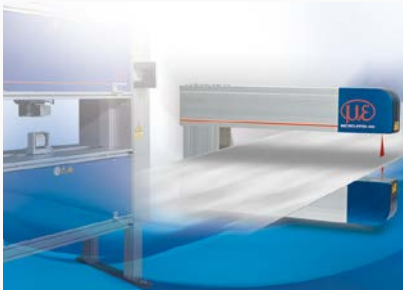

Measurement and inspection systems for quality assurance



Optical micrometers, fibre optic sensors and optical fibres



Colour recognition sensors, LED analysers and colour online spectrometer



MICRO-EPSILON Headquarters
Koenigbacher Str. 15 · 94496 Ortenburg / Germany
Tel. +49 (0) 8542 / 168-0 · Fax +49 (0) 8542 / 168-90
info@micro-epsilon.com · www.micro-epsilon.com

MICRO-EPSILON UK Ltd.
No.1 Shorelines Building · Shore Road · Birkenhead · CH41 1AU
Phone +44 (0) 151 355 6070 · Fax +44 (0) 151 355 6075
info@micro-epsilon.co.uk · www.micro-epsilon.co.uk